

Operating manual

Force measuring device for doors and gates.

KMG-2000-G – Operating manual
Document revision: 305-2310-001 EN34
– Translation –

Manufacturer:
GTE Industrieelektronik GmbH
Helmholtzstr. 21, 38-40
41747 Viersen
Germany

Support-Hotline: +49 2162 3703-0
E-mail: info@gte.de

© 2022 GTE Industrieelektronik GmbH – This document and all figures contained may not be copied, changed, or distributed without explicit approval by the manufacturer!

Subject to technical changes!

Brief Description

The force measuring device KMG-2000-G measures dynamic and static forces at door and gate closing edges as well as the duration of force effects. It complies with all requirements of EN 12453, which guarantees the complete testing and documentation of the force limitation capability of a system according to EN 12453, as well as the standard-compliant quality assurance for the production of doors according to EN 13849-1. DIN EN 16005 for automatic doors is also completely fulfilled. The compact and handy device shows the entire force-time curve in the integrated graphic display immediately after the five-second measuring period has elapsed and, in the background, combines three consecutive individual measurements into one measuring point average value in accordance with the standard specifications. The generous data memory of the KMG-2000-G offers space for 500 complete individual measurements or 166 complete standard measurements.

The following four measured values are determined for each measurement in order to assess the closing force in accordance with the standard.

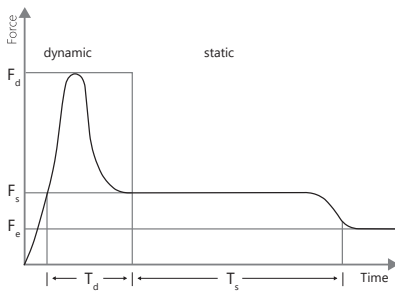

F_d max. dynamic force

F_s max. static force

F_e end force

T_d Time during where the measured force exceeds 150 N

T_s Time during where the measured force exceeds 25 N

Permitted Peak Force	Opening Widths from 50 to 500 mm	Opening Widths > 500 mm
Horizontally-moved gate	400 N	1400 N
Gate rotating on an axis perpendicular to the ground	400 N	1400 N
Vertically-moved gate	400 N	400 N
Gate rotating on an axis parallel to the ground	400 N	400 N
Barriers	400 N	400 N

Inhaltsverzeichnis

1	About this Manual	1
1.1	Explanation of Symbols	1
1.2	Storing this Manual	2
2	For your Safety	2
2.1	Intended Use	2
2.2	Standards and Regulations	3
2.3	Qualification of Personnel	3
2.4	Modifications	3
2.5	Abbreviations	3
3	Scope of Delivery	4
3.1	Accessories and Spare Parts	4
4	Transport and Storage Conditions	5
5	Setup and Function	5
5.1	Overview KMG-2000-G	5
5.2	Function	6
6	Menu Options	6
6.1	General Notes	6
6.2	“Options” Menu	6
6.2.1	Option 1: Activation Mode	6
6.2.2	Option 2: Delete Mode	7
6.2.3	Option 3: Check on Measured Values Held in Memory	7
6.2.4	Option 4: Lightning Adjustment	8
6.2.5	Option 5: Buzzer	8
6.2.6	Option 6: Switch off Time	8
6.3	Language Selection	9
7	Measurement Preparation	9
7.1	Turn on the KMG-2000-G	9
7.2	Performing Measurement	9
8	Carry out Measuring Operation	10
9	Measurement Analysis	10
9.1	Display Measured Values	10
9.2	Further Measurements	11
9.3	Storage of the Measurement Data and Graph via PC	11

10	Warnings and Error Messages	11
10.1	Battery Monitoring	11
10.2	Memory Space	12
10.3	Memory Space Empty	13
10.4	Device Still Loaded	13
11	Calibration	13
12	Disposal	13
13	Technical Data	14

1 About this Manual





This manual describes the correct use of the KMG-2000-G. It is aimed exclusively at knowledgeable specialist personnel.

1.1 Explanation of Symbols

This manual follows a certain structure to make it easy to work with and understand. The following designations are used throughout.

Operational objectives

Operational objectives specify the result to be achieved by following the subsequent instructions. Operational objectives are shown in **bolt print**.

Marking	Explanation
	This is followed by an instruction.
	Step-by-step instructions. Instructions for action are numbered in the order of their appearance.
	Results of action steps.
	Lists without a defined sequence.

Warnings

This manual uses the following information types.



DANGER!

This combination of symbol and signal word indicates an immediately dangerous situation which could lead to death or severe injuries if it is not avoided.



WARNING!

This combination of symbol and signal word indicates a possibly dangerous situation which could lead to death or severe injuries if it is not avoided.

**CAUTION!**

This combination of symbol and signal word indicates a possibly dangerous situation which could lead to minor injuries if it is not avoided.

**NOTICE!**

This combination of symbol and signal word indicates a possibly dangerous situation which could lead to property damage if it is not avoided.

**Tips and Recommendations**

This type of information provides information that is of direct importance for the further operation of the device.

1.2 Storing this Manual

Keep this documentation at hand so that you can look it up if necessary.

2 For your Safety

In order to use the KMG-2000-G safely, it is essential to read, understand and follow these instructions and the safety instructions contained therein.

2.1 Intended Use

The force measuring device KMG-2000-G is used for routine checking of closing forces on gates and doors, after new installation or for the prescribed annual inspection of existing gates with entry in the inspection book belonging to each gate. Via the built-in USB interface, the measured values can be transferred to a laptop or PC, which allows an exact analysis of the measured values and possible target deviations. The necessary software can be purchased additionally.

Intended use includes observance of these instructions and compliance with all applicable country-specific regulations. Furthermore, please observe the permissible peak forces of the applicable standards.

2.2 Standards and Regulations

When testing power operated doors and gates, the safety and accident prevention regulations applicable to the specific application must be observed.

The following standards and directives are of particular importance when handling the KMG-2000-G:

Regulation	Description
EN 12453	Industrial, commercial and garage doors and gates – Safety in use of power operated doors – Requirements and test methods
EN 13849	Safety of machinery – Safety-related parts of control systems – Part 1: General principles for design
EN 16005	Power operated pedestrian doorsets - Safety in use - Requirements and test methods
EN 16361	Power operated doors - Product standard, performance characteristics - Door systems other than swing doors, intended for power operation
ASR 1.7	Technical rule for workplaces – doors and gates
TS011 and TS012	DHF Code of practice for powered gates & barriers

2.3 Qualification of Personnel

All work with the KMG-2000-G may only be performed by qualified personnel. Qualified persons are those who can perform work on electrical systems due to their technical training, their knowledge and experience as well as knowledge of the relevant regulations and who can recognize possible dangers.

2.4 Modifications



WARNING!

Property damage due to unauthorized changes

Any form of unauthorized change can lead to property damage.

- **Modification of the KMG-2000-G is explicitly prohibited!**

2.5 Abbreviations

Abb.	Meaning
StM	Standard measurement
SiM	Single measurement

3 Scope of Delivery



No.	Description	Quantity
1	KMG-2000-G	1
2	USB-cable	1
3	Charging adapter	2

3.1 Accessories and Spare Parts



NOTICE!

Property damage caused by using the wrong components

The use of parts other than the original spare parts and the original accessories of the manufacturer can lead to property damage.

- **Only original spare part and original accessories of the manufacturer may be used!**

The following accessories are available for the KMG-2000-G:

Product
Distance Set
Software KMG-VD 2005

4 Transport and Storage Conditions



NOTICE

Material damage due to incorrect storage conditions

Mechanical loads caused by improper transport will result in material damage to the KMG-2000-G.

- **No mechanical stress may occur during transport.**

5 Setup and Function

5.1 Overview KMG-2000-G

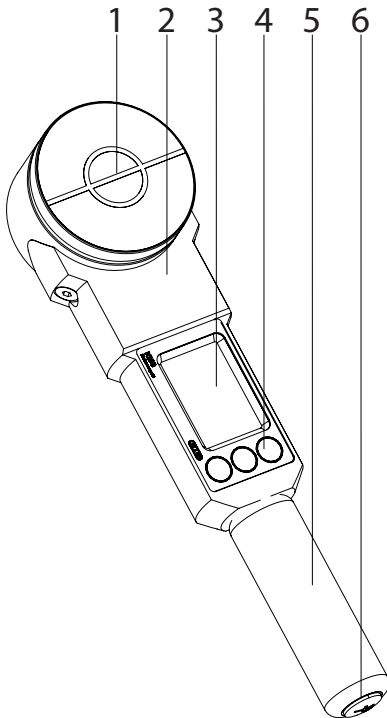

1. Measuring surface
2. Enclosure
3. Display
4. Softkeys
5. Handle
6. Battery compartment

5.2 Function

The KMG-2000-G force-measuring device is used for the routine, on-the-spot checking of closing forces on gates, e.g. following the installation of a new gate or for the prescribed annual inspection of existing gates, with the result being recorded in the inspection log book relating to each gate. The measured values can be transferred to a laptop or PC via the built-in USB interface. By using the KMG-VD 2005 software, an exact analysis of the measured values and possible target deviations can be carried out. The required software can be ordered as an accessories. The centerpiece of the KMG-2000-G contains an LCD display, on which all the measured values, the force curves, the measured-value memory management function, and user guidance are displayed.

6 Menu Options

6.1 General Notes

The function keys F1, F2 and F3 are used for calling up menu functions and for operating the device. The function of the keys is given by the symbols F1, F2 and F3 on the display.

If keys are not represented by these F symbols on the display, then these keys have no function or all keys have the same function. For approx. 5 seconds after switching on the KMG a menu is displayed allowing "Options" and "Language" to be selected.

F1:	Options	Call up menu for settings
F2:	New NM	Initiate new normal measurement
F3:Activate		Activate measuring

6.2 "Options" Menu

The various options can be selected one after the other via button F1. F2 activates the option displayed.

The number of the current option of a total of 6 is displayed top right.

Options:	1/6
next function:	F1
Activ.-mode:	F2
Exit:	F3

6.2.1 Option 1: Activation Mode

In the activation mode the type of "ready to measure" mode can be set. Button F1 switches the activation mode between "Automatic" and "Manual" and switches back to the main menu. The illustration shows that the "Manual" activation mode has been selected. Button F3 cancels the activation menu.

Active Mode:	
Man (Auto)	F1
Exit:	F3

Activation Mode "Auto": After every measurement the device is automatically switched to "ready to measure". As soon as a force > 20N acts on the test surface, a new force/time graph is plotted and then the current graphic is displayed and the measured values stored. This mode is used to record several measurements one after another which should be triggered automatically by hitting the test plate.

Activation Mode „Manual“: Prior to each new measurement the display must be switched from showing the graph to showing the measured values using any button as desired. A new measurement is then activated using button "F3". At this setting the measurement of the force cannot be triggered inadvertently by hitting the test plate.

6.2.2 Option 2: Delete Mode

In order to prevent accidental deletion, button F2 must be pressed for longer than 3 seconds.

The following delete functions can be selected on the delete menu:

- F1: entire memory is deleted
- F2: last individual measurement is deleted
- F3: last standard measurement along with its 3 individual measurements is deleted.

Options:	2/6
Next function:	F1
Delete results:	F2
Exit:	F3

	Delete results:	
all results:		F1
last SiM:		F2
last SiM:		F3

After actuating one of the selection buttons relating to the type of measurement values, you are asked once more in a further menu whether the measured values selected should be deleted.

F1 = Yes

F3 = No

By actuating F1 the data selected will be deleted.

6.2.3 Option 3: Check on Measured Values Held in Memory

By actuating button F2 the control display relating to those measured values deposited in the memory is called up.

The item stored „normal measurement / single measurement no.“ is displayed top right, e.g. in this case: 2 individual measurements within the 28th standard measurement

- F1 previous measurement
- F2 next measurement
- F3 display of the relevant force/time graph

Options:	3/6
Next function:	F1
Show results:	F2
Exit:	F3

Fd:	325N	28/2
Fs:	51N	<F1
Fe:	0N	>F2
Td:	40ms	F3

After browsing all individual measurements the relevant mean values appear. These are identified by an "m" on the display.

Fdm:	325N	28/3
Fsm:	51N	<F1
Fem:	0N	>F2
Tdm:	40ms	F3

6.2.4 Option 4: Lightning Adjustment

On this menu the lighting of the display can be switched on or off using button F1.

Options:	4/6
Next function:	F1
Illumination:	F2
Exit:	F3

6.2.5 Option 5: Buzzer

On this menu the internal buzzer can be switched on or off using button F1.

The buzzer gives an audible signal once measuring has been completed.

Options:	5/6
Next function:	F1
Beeper:	F2
Exit:	F3

6.2.6 Option 6: Switch off Time

The device does not have an on/off switch. After the device has been switched on by pressing any button as desired, it switches off automatically after a period of time that can be selected once no more buttons have been actuated or there is no communication.

Options:	6/6
First function:	F1
Turn-off time:	F2
Exit:	F3

Using button "F2" the time is increased
Using button "F1" the time is decreased

Turn-off time:	
6 minutes:	< F1
	> F2
Exit:	F3

Different times can be set ranging from 2 - 30 minutes



Switch off the KMG-2000-G

The device is switched on by pressing any button as desired and automatically switches off after a set time.

6.3 Language Selection

Language selection is only available after the device is switched on. As the device does not have an off switch, you must wait until it switches off automatically and then switch the device on again. You have access to the menu for selecting national languages from the loaded menu after switching the device on by pressing button F2.

Actuating the relevant button selects the desired national language and switches the device over to "ready to measure" mode. With F3 you navigate through the individual pages of the language selection.

KMG-2000-G	
Options:	F1
Language:	F2
Exit:	F3

German:	F1
English:	F2
	> F3

7 Measurement Preparation

7.1 Turn on the KMG-2000-G

► Press any key

⇒ KMG-2000-G is switched on.

After switching on, the "start" display appears for 5 seconds:
During this time the language selection or the options menu can be selected.

KMG-2000-G	
Options:	F1
Language:	F2
Exit:	F3

After 5 seconds the device is ready to carry out force measurements. The current status of the measured-value memory is displayed top left, e.g.:

2. Normal measurement
3. Individual measurement

StM: 2	SiM: 3	
Options:		F1
New StM:		F2
Activate:		F3

7.2 Performing Measurement

A measuring operation is activated by pressing button F3. The device is now ready to take measurements. The measuring operation is started if a force > 20 N acts on the test surface. The force/time measuring operation then runs (for a measuring period of 5 seconds).

StM: 2	SiM: 3	
Options:		F1
New StM:		F2
Start:		F>20N

8 Carry out Measuring Operation

Hold the test area centrally (inner circle) to the measuring points according to the standards. The measuring points are specifically prescribed in relation to the relevant type of gate construction.

Once the trigger threshold of 20 N has been passed, the force is measured over a period of 5 seconds. During this time the message "Measurement - Please wait" is displayed.

Once measuring has been completed, the force/time graph is analyzed automatically and the value relevant to the standard are determined.

Measurement
Please wait

Measurement
is calculated
Please wait

9 Measurement Analysis

9.1 Display Measured Values

Following evaluation, the force-time graph over the measurement period (5secs) is initially displayed and the dynamic force F_d (peak force) is displayed as a value.



Button F1: To switch between "normal display" (5 sec. measuring range) and „zoom display" of the dynamic range (1sec measuring range)

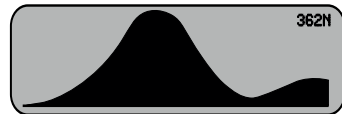

Button F2: To switch to display of 4 measured values:

Max. dynamic force:	F_d in N
Static force:	F_s in N
End force after 5 seconds:	F_e in N
Duration of dynamic force range:	t_d in ms

F_d :	326N	3/1
F_s :	82N	<F1
F_e :	17N	>F2
t_d :	128ms	F3

Button F3: Cancellation of display mode

Once the third measurement has been taken, the totals of 3 individual measurements required for the standard measurement have been made. If button F3 is now actuated, the mean values of the 3 standard measurements are displayed. The mean values are

F_{dm} :	237N	3/3
F_{sm} :	58N	<F1
F_{em} :	12N	>F2
t_{dm} :	86ms	F3

identified by the addition of an “m”. Buttons F1 and F2 do not have any function as the graphic representation of the mean values doesn’t make sense. If the mean values are displayed, the display mode can be cancelled using F3.

9.2 Further Measurements

You can return to the main menu by actuating button “F3” and

StM: 2	SiM: 3	
Options:		F1
New StM:		F2
Activate:		F3

to the “Start F>20N” display by actuating button “F3” once again

StM: 2	SiM: 3	
Options:		F1
New StM:		F2
Start:		F>20N

9.3 Storage of the Measurement Data and Graph via PC

The KMG-2000-G can be connected to any PC via a data link (USB). To do this, the cable supplied is connected to the USB jack on the KMG-2000 G and to a USB interface on the PC. Before data can be read from the KMG-2000-G the device must be switched on and the „KMG-VD 2005“ program on the computer has to be started. The software tests the connection and alerts you in case of mistakes in connection or malfunctions.

The KMG-2000-G can store a total of 500 graphs (equivalent to 166 standard measurements with 3 individual measurements). The data is preserved, even after the device has been switched off, with the result that the force graphs can also be read off the KMG-2000-G during a subsequent period.

The individual functions can be called up via the program menu of the software. You can find further explanations in the online help.

10 Warnings and Error Messages

10.1 Battery Monitoring

Whilst in operation the state of the rechargeable battery is checked. If the battery charge is low, the following message appears:

Charge batteries	
Exit:	F3

With the present level of charge further measurements can still be made.

If the “batteries low” message appears, the batteries are depleted and must be charged up.

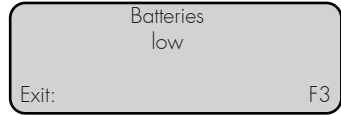

Changing batteries is not necessary as the device contains 2 rechargeable batteries. Changing batteries is only required if the batteries are damaged. As the batteries are monitored by an integrated charging regulator whilst charging and discharging, exchanging the batteries is only to be expected at the end of their useful life (which is several years).

Charging of the batteries is essentially carried out via the USB jack of the KMG. Three charging modes are provided for in this connection:

- The included power supply is equipped with a USB jack.
- The measuring device is connected via the USB cable to an adaptor used for car cigarette lighters.
- The KMG is charged whilst the USB is connected to a computer via the USB interface.

The shortest charging time is achieved using the power supply unit. If the batteries are empty, the charging time is approx. 3 - 4 hours.

Operating display:

- a) without KMG connection: LED green
- b) charging process: LED red
- c) charging process completed, holding charge: LED green for 19 secs and red for 1 sec.

The average power consumption in case of an unilluminated display is approximately 20 mA, and in case of an illuminated display approximately 40 mA. This gives an operating life of approximately 80 hours in normal display mode and approx. 40 hours in the case of an illuminated display.

10.2 Memory Space

Whenever the KMG switches to the “ready to measure” mode while the memory is full, the following message is displayed:
After actuating F1 branching off to the options menu

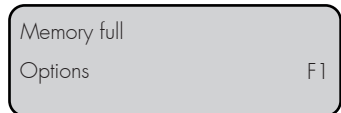

Notice: The device has a measured-value memory capable of storing a total of 500 graphs.

This means:

- a) 166 standard measurements à three individual measurements
- b) 500 standard measurements as single measurement
- c) other combinations of standard/individual measurements

10.3 Memory Space Empty

If no data is found while performing menu in 6.2.3, „Check on Measured Values Held in Memory“, the following message appears:

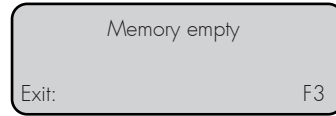

10.4 Device Still Loaded

If the KMG-2000-G is loaded with a force of more than 50 N when a measurement is started manually, further measurement is possible (F3 key), but the measurement accuracy is no longer guaranteed. The following message is displayed:



By pressing the F3 key, the measurement can be continued despite the basic force. If this warning is indicated without a load on the measurement area, the force gauge should be sent for maintenance to your service department.

11 Calibration

As a demand of EN 12453 and EN 16005, each force-measuring device has to be sent to for calibration at least once a year.

12 Disposal

Send the KMG-2000-G back to the manufacturer at the end of its useful life. This ensures environmentally friendly disposal of all components.

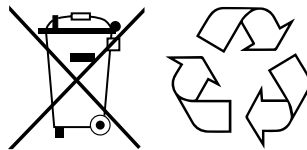

13 Technical Data

Power supply:	2 x 1,2 V NiMH-battery
Power consumption:	20 mA
Interface:	USB
Memory:	500 Individual measurements, corresponds to 166 Standard measurements with 3 individual measurements each
Temperature range	-10 ... +60 °C
Relative humidity	20 ... 90 % rF(non-condensing)
Test surface dimensions:	80 mm Ø, height 50 mm
Dimensions:	310 mm x 80 mm x 50 mm (l x b x h)
Weight:	1400 g
Measuring range:	25 N ... 2000 N
Measuring accuracy:	Typ. < 10 N
Measurement error:	25 N ... 200 N ±10 N 200 N ... 2000 N ± 5 % v. measured value
Spring constant:	500 N/mm
Rise/fall time:	≤ 5 ms

